

MasterTig | MLS 2300 ACDC AU

MasterCool | 20



Operating manual • English *EN*

OPERATING MANUAL

English

CONTENTS

1. PREFACE	3
1.1 General.....	3
1.2 Product introduction.....	3
2. INSTALLATION	4
2.1 Removal from packaging.....	4
2.2 Locating the machine.....	4
2.3 Serial number.....	4
2.4 Installation and main parts.....	4
2.5 Installation of the panel.....	5
2.6 Mains connection.....	6
2.7 Distribution network.....	6
2.8 Welding cable connections.....	6
2.9 Cooling unit to Mastercool 20.....	6
2.10 Shield gas.....	8
3. OPERATION	9
3.1 Welding processes.....	9
3.1.1 MMA welding.....	9
3.1.2 TIG welding Alternating Current.....	9
3.1.3 TIG Welding with Direct Current.....	9
3.1.4 Synergetic Pulsed TIG welding.....	10
3.1.5 Long Pulsed TIG welding.....	10
3.1.6 Spot welding function.....	10
3.1.7 MicroTack™ function.....	10
3.1.8 TIG-welding with mixed AC-DC current (MIX).....	10
3.2 Operation functions.....	10
3.2.1 Power source.....	10
3.2.2 Function panels.....	10
3.2.3 Saving welding settings.....	15
3.2.4 Adopting the saved settings.....	15
3.2.5 Remote control memory channels.....	15
3.2.6 SETUP functions.....	16
3.2.7 Foot pedal control R11F.....	16
3.3 Cooling unit operation Mastercool 20.....	16
3.4 Storage.....	16
3.5 SETUP-functions.....	16
3.6 Error codes.....	18
4. MAINTENANCE	18
4.1 Regular maintenance.....	18
4.2 Troubleshooting.....	19
4.3 Disposal of the machine.....	19
5. ORDERING NUMBERS	20
6. TECHNICAL DATA	21

1. PREFACE

1.1 GENERAL

Congratulations on your choice of the Kemppi MasterTig MLS ACDC welding system. Reliable and durable, Kemppi products are affordable to maintain, and they increase your work productivity.

This user manual contains important information on the use, maintenance and safety of your Kemppi product. The technical specifications of the device can be found at the end of the manual. Please read the manual carefully before using the equipment for the first time. For your safety and that of your working environment, pay particular attention to the safety instructions in the manual.

For more information on Kemppi products, contact Kemppi Oy, consult an authorised Kemppi dealer, or visit the Kemppi Web site at www.kemppi.com.

The specifications presented in this manual are subject to change without prior notice.

Important notes

Items in the manual that require particular attention in order to minimise damage and personal harm are indicated with the '**NOTE!**' notation. Read these sections carefully and follow their instructions.

Disclaimer

While every effort has been made to ensure that the information contained in this guide is accurate and complete, no liability can be accepted for any errors or omissions. Kemppi reserves the right to change the specification of the product described at any time without prior notice. Do not copy, record, reproduce or transmit the contents of this guide without prior permission from Kemppi.

1.2 PRODUCT INTRODUCTION

Kemppi Mastertig MLS™ ACDC is a family of TIG welding machines designed for industrial use, with characteristics especially suitable for welding materials like aluminium and stainless steel. Mastertig MLS 2300 ACDC AU is equipped with so called Voltage Reduction Device (VRD) function to avoid danger of electric shock. VRD maintains open circuit voltage under 35 V. The equipment consists of power source, function panel and welding torch. The cooling unit Mastercool 20 is used in water-cooled TIG welding. The welding torch can be either water-cooled or gas-cooled.

Multipurpose power source Mastertig MLS™ 2300 ACDC of 230 A maximum current is designed for demanding professional welding, suitable for electrode, TIG and pulsed TIG welding with both direct and alternating current. The power source is controlled with IGBT transistors with a frequency of approximately 65 kHz, and the operational functions with a microprocessor.

2. INSTALLATION

2.1 REMOVAL FROM PACKAGING

The equipment is packed in durable packages designed especially for it. However, it is necessary to check the equipment before using it to make sure that the equipment or any part of it has not got damaged during transportation. Also check that the delivery corresponds to your order and that you have received all necessary instructions for installing and operating the equipment. The packaging material is recyclable.

2.2 LOCATING THE MACHINE

Place the machine on a horizontal, stable and clean ground. Protect the machine from rain and direct sunshine. Check that there is enough space for cooling air circulation in front of and behind the machine.

2.3 SERIAL NUMBER

Serial number of the machine is marked on the rating plate. The serial number is the only proper means of identifying parts for a specific product. It is important to make correct reference to the serial number of the product when making repairs or ordering spare parts.

2.4 INSTALLATION AND MAIN PARTS



Front of machine

1. Function panel
2. Remote control connector
3. TIG torch control connector
4. Shield gas and current connector for TIG torch
5. (+) connector for electrode holder
6. (-) connector for earth cable

Markings for (+/-) poles on the machine front are embossed.

Rear of machine

1. Mains switch
2. Snap connector for gas

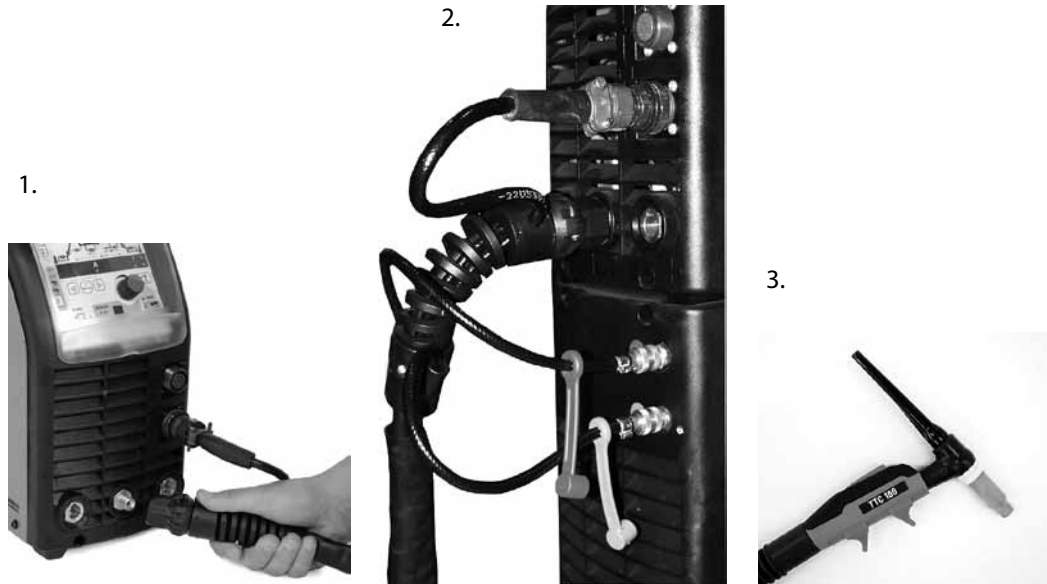

1. Installing gas-cooled torch
2. Installing water-cooled torch
3. Torch

2.5 INSTALLATION OF THE PANEL

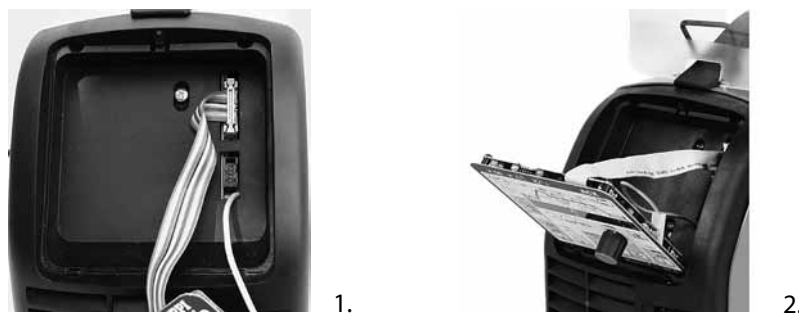

1. Fasten the cable connectors of the function panel to the power source (2 pieces).
2. Place the bottom edge of the panel behind the securing clips on the machine. Remove the fixing pin from the top edge with, for example, a screwdriver. Then gently push the upper part of the panel into place. Make sure that the cables do not get damaged, continue gently pushing the upper part of the panel until it clips into place. Finally, push the fixing pin back into its place.

2.6 MAINS CONNECTION

NOTE! Only an authorised electrician is allowed to install mains cable and plug!

The machine comes equipped with a three-metre power cord with a Schuko plug. Only an authorised electrician is allowed to replace the plug. The fuse and cable sizes are given in the Technical data at the end of this manual.

NOTE! This equipment's electromagnetic compatibility (EMC) is designed for use in an industrial environment. Class A equipment is not intended for use in residential location where the electrical power is provided by the public low-voltage supply system.

2.7 DISTRIBUTION NETWORK

All regular electrical devices without special circuits generate harmonic currents into distribution network. High rates of harmonic current may cause losses and disturbance to some equipment. Equipment complying with IEC 61000-3-12.

2.8 WELDING CABLE CONNECTIONS

The welding cables must be made of at least 16 mm² copper cable.

2.8.1 Choosing welding polarity in MMA welding

You can select the polarity electronically from the control panel, i.e. you do not have to switch the places of the (+) and (-) connectors. Connect always the negative connector to the work piece.

2.8.2 Earthing

If possible, always fasten the earth clamp of return current cable directly onto work piece.

1. Clean contact surface of earth clamp from paint and rust.
2. Fasten clamp properly, so that contact surface is as large as possible.
3. Check that clamp is fastened firmly.

2.9 COOLING UNIT TO MASTERCOOL 20

NOTE! Cooling liquid is injurious! Avoid also contact with skin or eyes. In case of injury, seek for medical advice.

Cooling unit Mastercool 20 together with TIG torch Kemppti TTC-W range enables TIG welding with water-cooled torch.

The cooling unit is installed beneath the power source with screws. Electrical connections are on the bottom of power source. Fill the reservoir with a 20 – 40 % mixture of glycol and water, or with any other suitable antifreeze. The capacity of the reservoir is 3 litres.

Mastercool 20



Installation of cooling unit:



Electrical connection for the cooling unit:

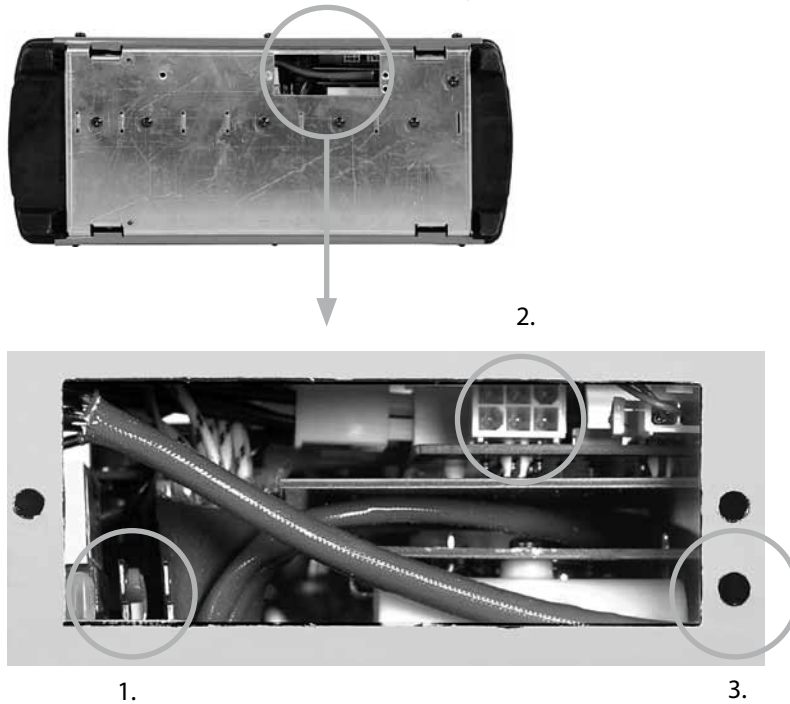

1. 230 V
2. Control connector
3. Equipment earth

NOTE! Only an authorised electrician is allowed to install electrical connection!

2.10 SHIELD GAS

NOTE! Handle gas bottle with care. There is a risk of injury if gas bottle or bottle valve is damaged!

Use inert gases such as argon, helium or argon-helium mixture as shield gas for TIG welding. Make sure that the gas flow regulator is suitable for the gas type used. The flow rate is set according to the welding current, joint form and the size of the electrode. A suitable flow rate is normally

8 – 10 l/min. If the gas flow is not suitable the welded joint will be porous. Spark ignition becomes more difficult if the gas flow is too high. Contact your local Kemppi dealer for choosing gas and equipment.

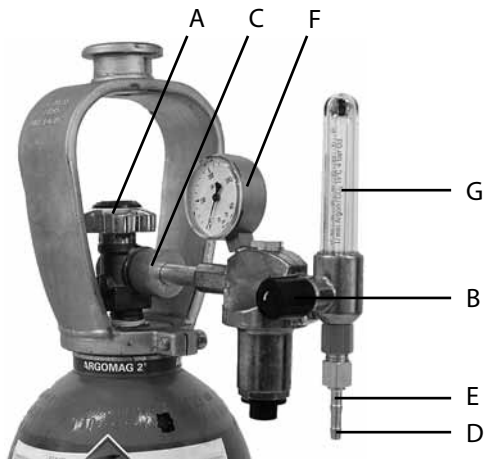

Parts of gas flow regulator

- A. Gas bottle valve
- B. Pressure regulation screw
- C. Connecting nut
- D. Hose spindle
- E. Jacket nut
- F. Gas bottle pressure meter
- G. Gas hose pressure meter

2.10.1 Installation of gas bottle

NOTE! Always fasten gas bottle properly in vertical position in a special holder on the wall or on a carriage. Remember to close gas bottle valve after having finished welding.

The following installation instructions are valid for most gas flow regulator types:

1. Step aside and open the bottle valve (A) for a while to blow out possible impurities from the bottle valve. Note! Watch out for the gas flow.
2. Turn the pressure regulation screw (B) of the regulator until no spring pressure can be felt.
3. Close needle valve if there is one in the regulator.
4. Install the regulator on bottle valve and tighten connecting nut (C) with a wrench.
5. Install hose spindle (D) and jacket nut (E) into gas hose and tighten with hose clamp.
6. Connect one end of the hose with the regulator and the other end with the power source. Tighten the jacket nut.
7. Open bottle valve slowly. Gas bottle pressure meter (F) shows the bottle pressure.

NOTE! Do not use the whole contents of the bottle. The bottle should be filled when the bottle pressure is 2 bar.

8. Open needle valve if there is one in the regulator.
9. Turn regulation screw (B) until hose pressure meter (G) shows the required flow (or pressure). When regulating flow amount, the power source should be switched on and the gun switch pressed simultaneously.

Close bottle valve after having finished welding. If the machine will be out of use for a long time, unscrew the pressure regulation screw.

3. OPERATION

NOTE! Welding in places presenting an immediate fire or explosion hazard is forbidden!

NOTE! Welding fumes may cause injury, take care of sufficient ventilation during welding!



3.1 WELDING PROCESSES

3.1.1 MMA welding

With Mastertig MLS™ ACDC power sources you can use all electrodes suitable for direct and alternating current welding between current limits of the power source. Both function panels (ACS, ACX) can be used for electrode welding when MMA welding is selected.

3.1.2 TIG welding Alternating Current

The Mastertig ACDC MLS™ power sources are specially designed for TIG welding aluminium with alternating current (AC). We recommend using WC20 electrodes (grey) for AC welding. The table is only given as a guide.

Welding current range AC			Electrode	Gas nozzle		Gas flow rate
min.	min.	maks.	WC20			Argon l/min
						
A	A	A	ø mm	number	ø mm	
15	25	90	1,6	4 / 5 / 6	6,5 / 8,0 / 9,5	6...7
20	30	150	2,4	6 / 7	9,5 / 11,0	7...8
30	45	200	3,2	7 / 8 / 10	11,0 / 12,5 / 16	8...10
40	60	350	4,0	10 / 11	16 / 17,5	10...12

The table and the panel scale are based on the use of WC20 (grey).

3.1.3 TIG Welding with Direct Current

DC welding is typically used when welding different grades of steel. We recommend using WC20 electrodes (grey) for DC welding.

A directive electrode selection table for DC welding.

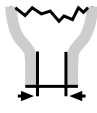
Welding current range	Electrode	Gas nozzle		Gas flow rate
DC	WC20			Argon
A	ø mm	number	ø mm	l/min
5 ... 80	1,0	4/5	6,5 / 8,0	5 ... 6
70 ... 140	1,6	4 / 5 / 6	6,5 / 8,0 / 9,5	6 ... 7
140 ... 230	2,4	6 / 7	9,5 / 11,0	7 ... 8

3.1.4 Synergetic Pulsed TIG welding

The ACX panel includes the synergetic TIG process, in which you only need to adjust the welding current while other pulse parameters are programmed. Pulsing frequency is high, which guarantees concentrated arc and increased welding speed.

3.1.5 Long Pulsed TIG welding

This method gives you the possibility to adjust all pulse parameters. Weld pool control is also easier. Long pulsed TIG welding is included in the ACX panel.

3.1.6 Spot welding function

In spot welding function you can to adjust the duration of the welds in the range 0-10 s.

3.1.7 MicroTack™ function

MicroTack welding is an efficient way to connect thin materials together using low heat input, which decreases distortions in base material.

3.1.8 TIG-welding with mixed AC-DC current (MIX)

Especially joining materials of different thicknesses can best be made out by using mixed current. Adjust values with SETUP-function if needed.

3.2 OPERATION FUNCTIONS

3.2.1 Power source

NOTE! Always switch the machine on and off from main switch. Do not use the mains plug for switching!

NOTE! Never watch the arc without a proper face shield designed for arc welding! Protect yourself and the surroundings against welding arc and hot spatters!

3.2.2 Function panels

Before welding starts, welding settings suitable for the work piece are chosen with the function panel.

The Kemppi Multi Logic System, MLS™, allows you to select the function panel based on the purpose of use: the ACS panel for AC TIG welding with basic functions, or the ACX panel with pulsed TIG, 4T-LOG or MINILOG control of welding current and memory channel functions.

The current display accuracy is $3\% \pm 2\text{ A}$, and the voltage display accuracy is $3\% \pm 0.2\text{ V}$.

Indicator lights



1. Power On
2. Thermal overload of power source
3. Wrong mains voltage, over or under-voltage

ACS welding panel – basic functions

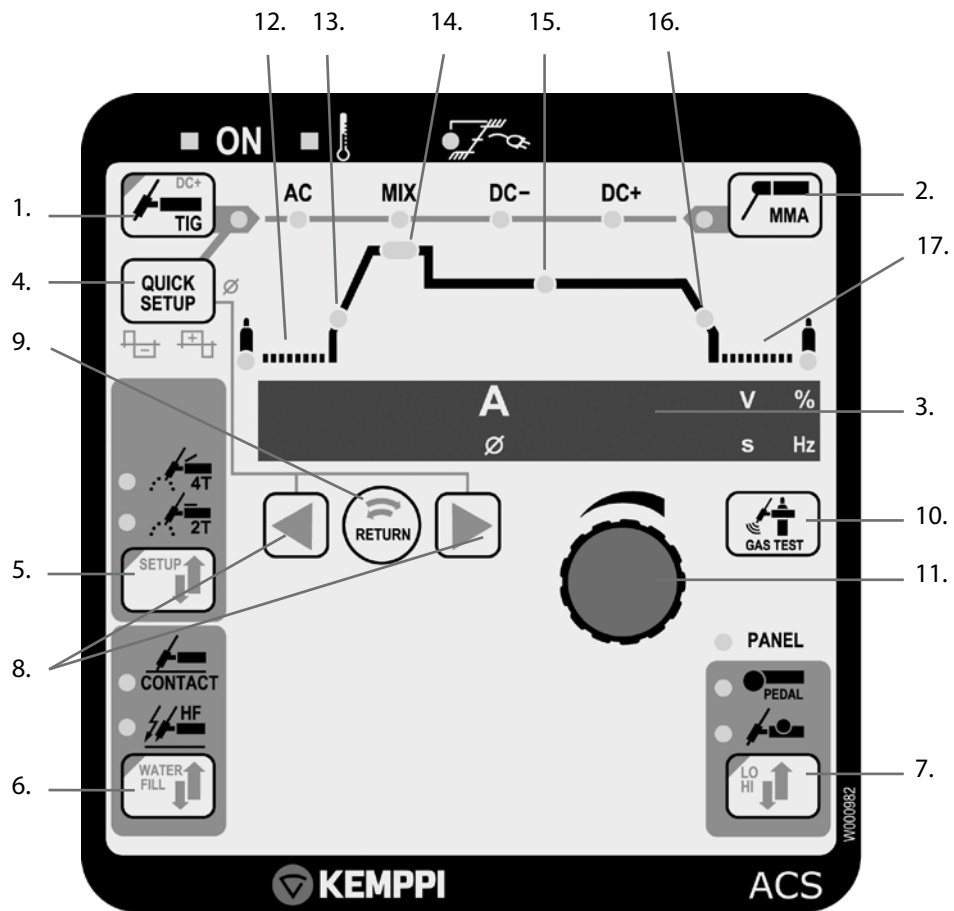

1. Selection button and indicators for TIG welding and current type
2. Selection button and indicators for MMA welding and current type
3. Current and voltage display, display for other welding parameters
4. QUICK SETUP button for MMA and TIG adjustments (e.g. balance adjustment)
5. Selection of the torch switch function 2T/4T
6. HF/contact TIG (WATER FILL) button
7. Remote control selection button (setting the limits for the adjustment range: LO/HI)
8. Welding parameter selection buttons (arrow buttons)
9. RETURN button / returns to welding current
10. GAS TEST button
11. Potentiometer for welding parameter adjustment
12. Pre-gas 0.0 - 10.0 s
13. Upslope 0.0 - 10.0 s
14. Hot Start current 100 – 150 % (100 %: not in use)
15. Welding current
16. Downslope 0.0 - 15.0 s
17. Post-gas 1.0 - 30.0 s

1. MMA

Select MMA welding by pressing the MMA selection button. The indicator light next to the button will light up when MMA is selected. The current type indicator light indicates which current is selected: AC, DC-, DC+. Change the current type by pressing the MMA button again, and the indicator light will indicate the selected current.

Press the QUICK SETUP button if you wish to adjust the dynamics or ignition pulse to MMA welding. Navigate with the arrow buttons and adjust with the potentiometer. Quit by pressing again QUICK SETUP- or RETURN-button.

1. Dynamics ("Arc" -9 ... 0 ... +9)

You will see the numerical value corresponding to the MMA dynamics in the display. Factory setting for all electrode types is zero. You can change the value by turning the pulse potentiometer. If numerical value is adjusted negative (-1...-9) the arc is softened, and the amount of spatter decreases when welding at the upper end of the recommended current range of the electrode. On the positive side (1...9) the arc is rough.

2. Ignition pulse (Hot -9 ... 0 ... +9)

You will see on the display the numerical value corresponding to the MMA hot start pulse. You can adjust the value by turning the potentiometer. A positive value corresponds to a more powerful pulse, with zero being the default setting.

2. TIG welding

Select TIG welding by pressing the TIG button. You can change the current type by pressing the selection button again (AC, MIX, DC-, DC+). Selecting DC+ requires holding down the button. According to selected current mode you can adjust parameters by using QUICK SETUP -funktion. Quit from QUICK SETUP -funktion by pressing QUICK SETUP -button. At the same time you can see recommended diameter for electrode.

AC TIG (alternating current TIG)

Intended for welding aluminium. You can adjust, for example, the balance and frequency of the alternating current with the QUICK SETUP and arrow buttons. The following welding parameters can be adjusted:

1. Balance (bAL -50 ... 0, factory setting -25%)

A positive balance value breaks up aluminium oxide more effectively but heats the electrode more than the workpiece (the tip blunts).

A negative balance value increases heat generation and penetration in the base metal, while decreasing oxide break-up.

If you wish to increase electrode temperature when welding with a blunt-headed electrode, adjust the balance in the positive direction, and if you wish to decrease electrode temperature when welding with a sharp electrode, adjust the balance correspondingly in the negative direction.

At the factory setting, the electrode tip remains almost sharp.

A sharp electrode allows welding with a narrower arc, achieving a narrower weld and deeper penetration than with a blunted electrode. Narrow welding is especially useful when fillet welding.

Welding with a blunted electrode produces a wide arc, which also widens the area of oxide break-up. Application areas include repair welding and casting.

2. Frequency (FrE 50 ... 250 Hz, factory setting 60 Hz)

Raising the frequency will make the arc slightly more stable and narrow, but it will increase the noise caused by arc.

3. Selection of AC waveform, sine or square wave (SinuS/SquArE)

The waveform affects the noise level and penetration of the arc. A sine waveform generates a lower noise level, while a square wave has better penetration (factory setting).

4. Hot Start time for the 2T function (H2t 0.1 s...5.0 s, factory setting 1 s)

Pre-heating timer for the 2T switch function. The workpiece can be pre-heated (Hot Start) with both AC and DC currents. The time set here remains in effect for DC TIG current types.

3. MIX TIG (mixed current AC/DC-)

With mixed current frequency and balance of alternating current are determined by adjustments made for AC-current. Adjust by choosing sections 4. – 5. if needed.

The following QUICK SETUP parameters can be adjusted:

1. AC-time (AC 10 ... 90 %, factory setting 50 %)
2. Cycle time (CYc 0.1 ... 1.0 s, factory setting 0.6 s)
3. DC-current (DC(-) 50 ... 150 %, factory setting 100 %)
4. Balance (bAL -50 ... 0 ... +10 %, factory setting -25 %)
5. Frequency (FrE 50 ... 250 Hz, factory setting 60 Hz)
6. Selection of AC waveform, sine or square wave (SinuS/SquArE)
7. Hot Start time for the 2T function (H2t 0.1 s...5.0 s, factory setting 1.0 s). Can be seen only on the 2T function.

Factory setting is marked with a dot after the numeric value.

Growing DC-current increases penetration but decreases cleaning effect.

4. DC- (or DC+) (direct current)

No parameters to adjust. You can see recommended diameter for elektrode by pressing QUICK SETUP -button. Diameter depends on current adjustment.

HF/contact ignition in TIG welding (water fill)

TIG arc can be started either with high frequency (HF) or without (contact ignition). HF ignition is chosen by pressing the HF CONTACT button to turn on the HF light.

If you use water-cooled torch you can fill it with water by pressing the HF CONTACT button for more than 2 seconds. The display reads 'COOLER'.

Welding torch switch 2 sequence function

Gas flow starts when the torch switch is pressed. Welding starts, and the current will rise to the Hot Start current within the up-slope time, remain at that level for the set time (H2t) and then change to the welding current. The Hot Start function can be disabled and green panel light switches off when the Hot Start current is adjusted to 100 %. The current will then rise directly to the welding current level within the up-slope time. Release the torch switch, and the current starts to drop, and after the selected down-slope time the arc is broken. After this, the shield gas will flow for the time selected.

Welding torch switch 4 sequence function

Gas flow starts when the torch switch is pressed. Release the torch switch. The ignition spark ignites the arc, and the current will rise to the Hot Start current within the up-slope time. You can switch from Hot Start current to welding current with a short press of the torch switch. You can disable the Hot Start function by adjusting the Hot Start current to zero per cent. The current will then rise directly to the welding current level within the up-slope time.

Press the torch switch down, and the welding continues. Release the torch switch, and the current starts to drop and after the selected down-slope time the arc is broken. After this, the shield gas will flow for the time selected.

Remote control

If you choose to adjust the welding current with a remote control unit you need to connect the unit and select the remote control selection button. The PANEL light switches off, and you can select the unit (R10, foot pedal control R11F, or torch control). The foot pedal control works only in 2T mode. Hold the remote control selection button (LO/HI) down to adjust the limits of the remote control's adjustment range.

Adjustment of parameters

To select TIG welding parameters you only need to use two buttons: arrow-left and arrow-right. Red panel light shows parameter you have chosen. Adjustment is done with the potentiometer. When pressing the RETURN button, adjustment of parameters goes straight to welding current. The display shows automatically numeric values and the units of the parameters. When you adjust the parameters, you can see the value on the numerical display. After 10 seconds, the display will return to the welding current.

Welding panel ACX
– pulsed TIG and MINILOG function with memory

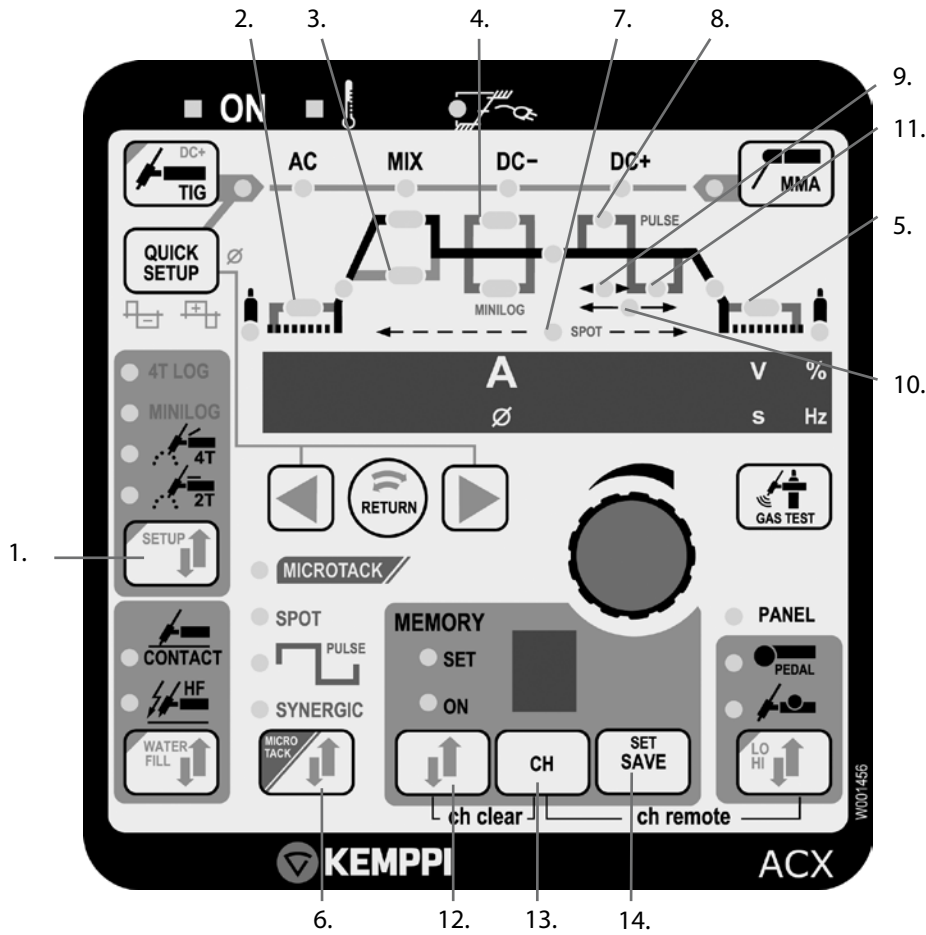

1. 4T-LOG and MINILOG function selections
2. Search arc 5 – 90 % of welding current
3. Start-current 80 – 150 %
4. Minilog-current 10 – 150 % of welding current
5. Tail arc 5 – 90 % of welding current
6. Selection for spot, synergetic quick pulse and long pulse
7. Spot time 0,0 – 10,0 s
8. Pulse current 10 A – power source max.
9. Pulse ratio 10 – 70 % of pulse time
10. Frequency 0.2 – 250 Hz DC-TIG, 0.2 – 20 Hz AC-TIG
11. Base current 10 – 70 % of pulse current
12. MEMORY, memory function
13. Selection of channel in memory function
14. SAVE/memory values

If wanted in SETUP-function you can disable search arc and tail arc functions. Hot Start (Soft Start)- and Minilog -currents can be disabled by adjusting the values to 100 per cent (the same as the welding current).

Minilog

When torch switch is pressed gas flow starts. When you release the torch switch current goes through upslope to Hot Start or Soft Start -current depending on adjustments and by pressing shortly again to welding current. After another short press it goes to Minilog operation, and you can select from two current levels: the welding current and the Minilog current. You can move from one to the other by quickly pressing the torch switch. Press the torch switch for one second, release it and current goes to downslope and tail arc. Arc is cut by short press of the switch.

4T-LOG

When torch switch is pressed current goes to search arc; after the switch is released current goes to welding current within the upslope time. When the switch is pressed again, current goes to downslope and then to the tail arc. Current stops when the switch is released.

Synergetic quick pulse

Press the PULSE button twice and the synergetic light turns on. Pulse parameters are calculated automatically when average welding current is selected. Other pulse selections are not necessary.

Long pulse

Long pulse method gives you the possibility to adjust all pulse parameters (pulsing frequency, pulse ratio, pulse current and pause current). You can also adjust the welding current, in which case you receive a new pulse current value. Pulse ratio and pause current percentage remain constant. When you adjust the pulse ratio, pulse current or pause current, the new average welding current value is shown on the display.

Spot welding function

The function can be used both in 2T and 4T mode. Enter the spot duration by pressing arrow button, and when the led is lit you can choose the spot time needed by turning the pulse potentiometer.

TIG -Micro tack welding function (MicroTack™)

You can select the Micro Tack function with a long press of the SPOT arrow button. When this function is activated, the machine automatically enables the DC- welding mode, 2T switch mode and contact ignition. Also the upslope and downslope values are set to zero and SPOT led starts to blink. To inactivate the Micro Tack you press briefly the same arrow button.

This function can be used with HF ignition and 4T mode. The duration of the spot weld can be adjusted by pressing Quick Setup button and selecting a value in the range 1-200 ms. The Micro Tack welding current can be adjusted with the control knob, when the welding current led is on.

3.2.3 Saving welding settings

ACX panel has 10 memory channels for user settings. The selections are made in the MEMORY field. Not only welding parameters but also function selections can be saved in the memory. MMA welding values can also be stored in memory channels. Proceed as follows:

1. Press MEMORY button and if the SET light starts blinking the channel is free. If a channel is in use, the ON light will light up. Press again, and the SET light will be continuously lit.
2. Select memory channel by pressing CH button.
3. Select the parameters and press SAVE button.
4. Press MEMORY button twice. ON led is lit.
5. Start welding.

If the saved settings need to be adjusted the led has to be moved from ON to SET position in order to select parameters. Press the SAVE button.

When the memory function is in OFF state (no lights on) it is also possible to save the currently used panel parameters by pressing SET/SAVE, by choosing channel ja by pressing SET/SAVE again. Channel is cleared if MEMORY and CH buttons are pressed simultaneously in SET mode.

3.2.4 Adopting the saved settings

1. Select MEMORY by pressing the button.
2. Select memory channel by pressing the CH button.
3. Start welding.

3.2.5 Remote control memory channels

Memory channels are selected by pressing simultaneously both REMOTE and CH button. With the remote control you can retrieve saved settings on memory channels 1-5. The selected channel is marked with a dot.

3.2.6 SETUP functions

A so called SETUP state is included for modifying panel functions. You can enter the SETUP state by pressing the SETUP button longer than normally. Exit is performed in the same way. You can select the function (see list below) by pressing the arrow buttons and then change the setting by turning the potentiometer. See SETUP-function table on the next page.

3.2.7 Foot pedal control R11F

First read "ACS Welding Panel – Basic Functions" point "Remote control" for installing the remote control ready for operation. Foot pedal R11F is used in TIG welding, and its control range is adjustable. The minimum value of control range is set with the panel potentiometer when the pedal is not pressed, display shows "LO". Control range maximum is set similarly by pressing first the PEDAL LO/HI button on the panel, display shows "HI". Welding is started with a light press on the pedal, the arc ignites to the set minimum current. Welding current goes to maximum when the pedal is pressed to the bottom. The arc is broken when the pedal is released. Adjust again if necessary.

3.3 COOLING UNIT OPERATION MASTERCool 20

The operation of Mastercool cooling unit is controlled by the power source. The cooling unit pump starts automatically when welding starts. Proceed as follows:

1. Start power source.
2. Check water level and input flow of the reservoir, add liquid if needed.
3. If you use a water-cooled torch you can fill it with water by pressing WATER FILL button for more than 2 seconds.

The pump operates for 4 another minutes after welding has been finished to cool the water to the same temperature as in the machine surrounds. This reduces the need of service.

Thermal overload

The thermal overload light is lit, the machine stops and display shows COOLER when temperature control of the machine has detected cooling water overheating. The cooling unit fan cools down the water, and when the light goes out welding can be started again.

Water flow signal

Display shows COOLER when water flow is blocked.

3.4 STORAGE

The machine must be stored in a clean and dry room. Protect the machine from rain and direct sunshine in places where temperature exceeds +25 °C.

3.5 SETUP-FUNCTIONS

SETUP-function	Display		*C = Common: applies to all memory channels Factory setting with a grey background
Upslope current dependency (*C)	A1	ON	The upslope time is determined by the current.
		OFF	The upslope time remains as set.
Downslope current dependency (*C)	A2	ON	The downslope time is determined by the current (the user may set the slope gradient).
		OFF	The downslope time remains as set.

TIG Antifreeze (*C)	A3	ON	TIG Antifreeze on.
		OFF	TIG Antifreeze off.
MMA Antifreeze (*C)	A4	ON	MMA Antifreeze on.
		OFF	MMA Antifreeze off.
VRD (*C)	A7	ON	VRD mode: idle voltage < 35 V
		OFF	Normal idle voltage
2T downslope cut off	A8	ON	In 2T mode, cut off the downslope with a quick push of the start button.
		OFF	Quick push has no effect.
Tacking automatics	A9	ON	If welding has lasted less than 3 seconds, no downslope when welding is stopped.
		OFF	Tacking automatics off.
Limitation of rate of current rise with high currents	A10	ON	If the current is over 100 A and UpSlope is 0.0 sec., there is a 0.2-second slope from half the welding current.
		OFF	Current rises directly to maximum.
MMA/TIG method selection with remote control (C*)	A12	ON	TIG = the start of remote control scale. MMA = the end of the scale.
		OFF	Remote control as a normal current regulator.
SearchArc On/Off	A13	ON	SearchArc on.
		OFF	SearchArc off.
Current freeze function	A14	ON	During the downslope, the current can be 'frozen' at a certain level by pushing the start button.
		OFF	Freeze function off.
Memory channel selection with Up/Down buttons (C*)	A15	ON	The Plus/Minus buttons on the remote control can be used to select the memory channel.
		OFF	The buttons adjust the current.
Activation of the Plus/Minus buttons (C*)	A16	ON	The Plus/Minus remote control is always active.
		OFF	The Plus/Minus remote control is active only when selected by pressing the REMOTE button.
Water cooler flow guard (C*)	A17	ON	Flow guard on.
		OFF	Flow guard off.
Water cooler automatic control (C*)	A19	ON	Automatic control on.
		OFF	Water cooler runs constantly.
Water cooler temperature guard (C*)	A20	ON	Water cooler temperature guard selected.
		OFF	Temperature guard off.
Automatic remote control device recognition (C*)	A21	ON	Automatic recognition on, control cannot be selected if it is not connected.
		OFF	Automatic recognition On/Off. Controller can be selected even if it is not connected.
Tail arc	A22	ON*	Tail arc on. * 4T LOG
		OFF**	Tail arc off. ** MINILOG

3.6 ERROR CODES

The machine always checks its operation automatically during start-up and reports any failures detected. If failures are detected during start-up, they are shown as error codes on the control panel display.

Err3: Overvoltage or undervoltage

The machine has stopped the welding because it has detected momentary voltage spikes or continuous mains over- or under-voltage dangerous to the machine. Check the quality of the supply network.

Err4: Power source overheating

The power source has overheated. The cause may be one of the following:

- The power source has been used for a long time at maximum power.
- The circulation of cooling air to the power source is blocked.
- The cooling system has experienced a failure.

Remove any obstacle to air circulation, and wait until the power source fan has cooled down the machine.

4. MAINTENANCE

NOTE! Watch out for mains voltage when handling electric cables!

Degree and circumstances of machine utilisation should be taken into consideration when planning product maintenance. Careful use and preventive maintenance help to avoid unnecessary production disturbances and breaks. Check the condition of the welding and connection cables daily. Do not use damaged cables.

4.1 REGULAR MAINTENANCE

4.1.1 Every sixth months

NOTE! Disconnect the plug of the machine from the mains socket and wait for ca. 2 minutes (capacitor charge) before removing the casing plate.

The following maintenance operations should be carried out at least every sixth months:

- Electric connections of the machine - clean any oxidised parts and tighten any loose ones.

NOTE! You must know the correct tension torques before you start repairing the connections.

- Clean the inner parts of the machine from dust and dirt e.g. with a soft brush and a vacuum cleaner. Do not use compressed air because there is the danger that the dirt is packed even more tightly in the gaps of the cooling profiles. Do not use a pressure washer.

NOTE! Only an authorised electrician may repair the machine.

4.1.2 Service contract

KEMPPI service workshops make special service contracts with customers about regular maintenance. All parts are cleaned, checked and if necessary, repaired. Also the operation of welding machine is tested.

4.2 TROUBLESHOOTING

Power On light is not lit.

There is no power in the machine.

- Check mains fuses, replace blown fuses.
- Check mains cable and plug, replace defect parts.

The machine is not welding properly.

There are plenty of spatters during welding. Weld joint is porous or power supply is insufficient.

- Check welding settings and adjust if needed.
- Check gas flow and gas hose connection.
- Check that earth clamp is properly fastened and that earth cable has no defects. Change the position if necessary and replace defect parts.
- Check welding torch cable and connector. Tighten the connection and replace defective parts.
- Check the consumable parts of welding torch. Clean and replace defect parts.
- Check mains fuses, replace blown fuses.

Power source overheat indicator light is lit.

Power source is overheated.

- Check that there is enough free space behind the machine for cooling air circulation.
- Check cooling unit for water circulation, clean cooling unit filter and air grate. Add cooling liquid if necessary.

For further information and assistance, contact your nearest Kemppi service workshop.

4.3 DISPOSAL OF THE MACHINE



Do not dispose of electrical equipment with normal waste!

In observance of European Directive 2002/96/EC on waste electrical and electronic equipment, and its implementation in accordance with national law, electrical equipment that has reached the end of its life must be collected separately and taken to an appropriate environmentally responsible recycling facility.

The owner of the equipment is obliged to deliver a decommissioned unit to a regional collection centre, per the instructions of local authorities or a Kemppi representative. By applying this European Directive you will improve the environment and human health.

5. ORDERING NUMBERS

Power source Mastertig MLS™ 2300 ACDC AU			6162300AU
Panels			
ACS			6162805
ACX			6162804
Cables			
Welding cable	16 mm ²	5 m	6184103
Welding cable	25 mm ²	5 m	6184201
Welding cable	25 mm ²	10 m	6184202
Welding cable	35 mm ²	5 m	6184301
Earth cable	16 mm ²	5 m	6184113
Earth cable	25 mm ²	5 m	6184211
Earth cable	25 mm ²	10 m	6184212
Earth cable	35 mm ²	5 m	6184311
Torches			
TTC 160		4 m	627016004
TTC 160		8 m	627016008
TTC 160		16 m	627016016
TTC 220		4 m	627022004
TTC 220		8 m	627022008
TTC 220		16 m	627022016
Gas flow meter AR/clock			6265136
Cooling unit			
Mastercool 20			6162900
Water-cooled torches			
TTC 200W		4 m	627020504
TTC 200W		8 m	627020508
TTC 200W		16 m	627020516
TTC 250W		4 m	627025504
TTC 250W		8 m	627025508
TTC 250W		16 m	627025516
Optional device			
TIG torch controls			
RTC 10			6185477
RTC 20			6185478
Remote control			
R 10			6185409
R11F			6185407
Transport unit			
T130			6185222
T110			6185251

6. TECHNICAL DATA

Power source Mastertig MLS™ 2300 ACDC AU		
Connection voltage	50/60 Hz	1~240 V -20%...+10%
Rated power		
40% ED TIG	230 A	5,7 kVA
60% ED TIG	200 A	4,8 kVA
100% ED TIG	170 A	3,9 kVA
40% ED MMA	180 A	6,0 kVA
60% ED MMA	150 A	4,8 kVA
100% ED MMA	120 A	3,7 kVA
Connection cable	H07RN-F	3G2.5 (3.3 m)
Fuse (delayed)		15 A
Welding current range		
	TIG	3 A / 10,0V...230 A / 19,2V
	MMA	10 A / 20,5 V...180 A / 27,2 V
Max welding voltage		32 V / 180 A (MMA)
Electrode sizes to be welded		Ø 1,5...4,0 mm
Open circuit voltage, max.		58 V
Welding current adjustment		stepless
Efficiency at nominal values		82 % (180 A / 27,2 V), 78 % (230 A / 19,2 V)
Power factor at nominal values		0,99
Open circuit power	TIG	6 W
	MMA	180 W
External dimensions	LxWxH	430 x 180 x 390 mm
	height	650 mm (power source + cooling unit)
Weight		15 kg
Cooling unit (TIG-welding) Mastercool 20		
Connection voltage	50/60 Hz	1~240 V -20 %...+10 %
Connection capacity	100 % ED	50 W
Cooling power		1,0 kW
Start pressure, max		4,0 bar
Cooling liquid	20 % - 40 %	glycol-water
Reservoir volume		approx. 3 l
External dimensions	LxWxH	500 x 180 x 260 mm
Weight		8 kg

Power source and cooling unit		
Operating temperature range		-20 °C +40 °C
Storage temperature range		-20 °C +60 °C
EMC class		A
Degree of protection		IP 23 C
Recommended generator Smin 8 kVA		

KEMPPI OY

Hennalankatu 39
PL 13
FIN-15801 LAHTI
FINLAND
Tel +358 3 899 11
Telefax +358 3 899 428
export@kemppi.com
www.kemppi.com

Kotimaan myynti:

Tel +358 3 899 11
Telefax +358 3 734 8398
myynti.fi@kemppi.com

KEMPPI SVERIGE AB

Box 717
S-194 27 UPPLANDS VÄSBY
SVERIGE
Tel +46 8 590 783 00
Telefax +46 8 590 823 94
sales.se@kemppi.com

KEMPPI NORGE A/S

Postboks 2151, Postterminalen
N-3103 TØNSBERG
NORGE
Tel +47 33 346000
Telefax +47 33 346010
sales.no@kemppi.com

KEMPPI DANMARK A/S

Literbuen 11
DK-2740 SKOVLUNDE
DANMARK
Tel +45 4494 1677
Telefax +45 4494 1536
sales.dk@kemppi.com

KEMPPI BENELUX B.V.

Postbus 5603
NL-4801 EA BREDA
NEDERLAND
Tel +31 765717750
Telefax +31 765716345
sales.nl@kemppi.com

KEMPPI (UK) Ltd

Martti Kemppi Building
Fraser Road
Priory Business Park
BEDFORD, MK44 3WH
UNITED KINGDOM
Tel +44 (0)845 6444201
Telefax +44 (0)845 6444202
sales.uk@kemppi.com

KEMPPI FRANCE S.A.S.

65 Avenue de la Couronne des Prés
78681 EPONE CEDEX
FRANCE
Tel +33 1 30 90 04 40
Telefax +33 1 30 90 04 45
sales.fr@kemppi.com

KEMPPI GmbH

Otto-Hahn-Straße 14
D-35510 BUTZBACH
DEUTSCHLAND
Tel +49 6033 88 020
Telefax +49 6033 72 528
sales.de@kemppi.com

KEMPPI SPÓŁKA Z O.O.

Ul. Borzymowska 32
03-565 WARSZAWA
POLAND
Tel +48 22 7816162
Telefax +48 22 7816505
info.pl@kemppi.com

KEMPPI AUSTRALIA PTY LTD.

13 Cullen Place
P.O. Box 5256, Greystanes NSW 2145
SMITHFIELD NSW 2164
AUSTRALIA
Tel. +61 2 9605 9500
Telefax +61 2 9605 5999
info.au@kemppi.com

ООО КЕМППИ

Polkovaya str. 1, Building 6
127018 MOSCOW
RUSSIA
Tel +7 495 739 4304
Telefax +7 495 739 4305
info.ru@kemppi.com

ООО КЕМППИ

ул. Полковная 1, строение 6
127018 Москва
Tel +7 495 739 4304
Telefax +7 495 739 4305
info.ru@kemppi.com

KEMPPI, TRADING (BEIJING) COMPANY, LIMITED

Room 420, 3 Zone, Building B,
No.12 Hongda North Street,
Beijing Economic Development Zone,
100176 Beijing
CHINA
Tel +86-10-6787 6064
+86-10-6787 1282
Telefax +86-10-6787 5259
sales.cn@kemppi.com
肯倍贸易 (北京) 有限公司
中国北京经济技术开发区宏达北路12号
创新大厦B座三区420室 (100176)
电话 : +86-10-6787 6064
+86-10-6787 1282
传真 : +86-10-6787 5259
sales.cn@kemppi.com

KEMPPI INDIA PVT LTD

LAKSHMI TOWERS
New No. 2/770,
First Main Road,
KAZURA Gardens,
Neelangarai,
CHENNAI - 600 041
TAMIL NADU
Tel +91-44-4567 1200
Telefax +91-44-4567 1234
sales.india@kemppi.com